

RADIATOR

FREQUENT FAILURES



**A guided reference
to prevent radiator
from failures**



RADIATOR

The Radiator Professionals



RADIATOR

THE RADIATOR PROFESSIONAL

HIGH QUALITY RADIATOR PRODUCT WITH HIGH PERFORMANCE

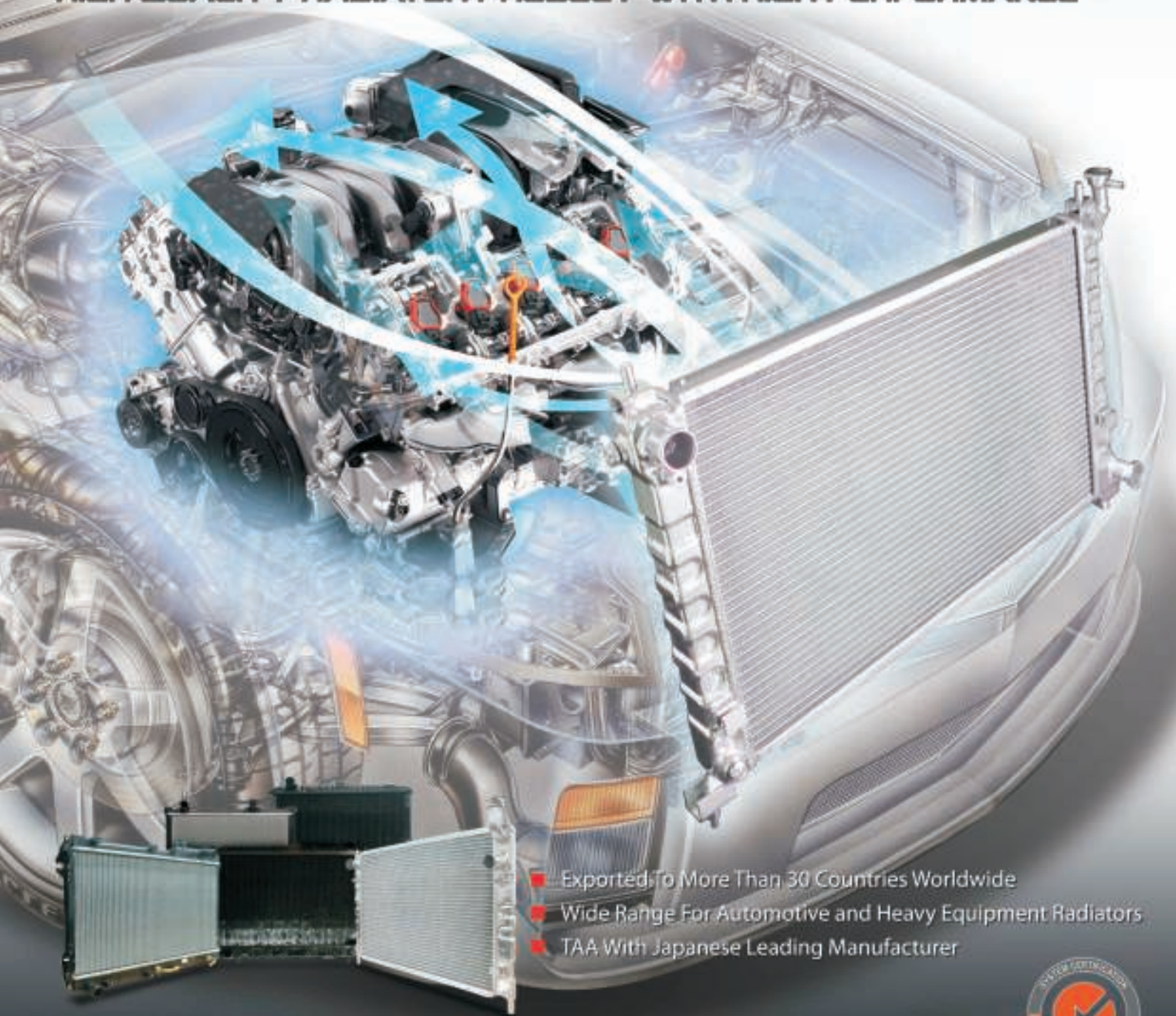

- Exported To More Than 30 Countries Worldwide
- Wide Range For Automotive and Heavy Equipment Radiators
- TAA With Japanese Leading Manufacturer



ISO 9001:2015
ISO 14001:2015
ISO/TS 16949

Manufactured by ADR Group of Companies

RADIATOR

FREQUENT FAILURES

**A guided reference
to prevent radiator
from failures**



RADIATOR

The Radiator Professionals

INDEX

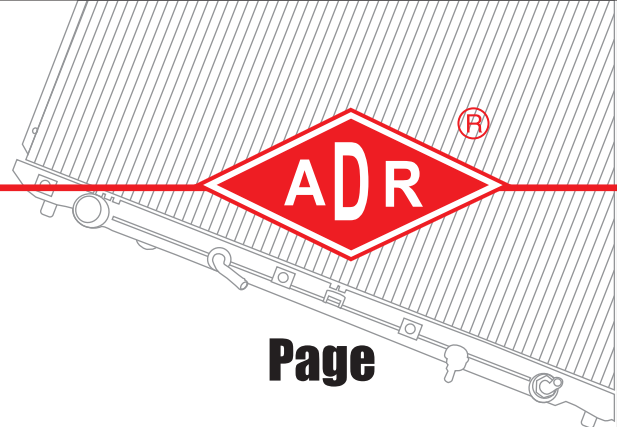

Page

A. HOW RADIATOR WORK?	1
B. RADIATOR PARTS	2
C. ENGINE COOLING SYSTEM	3
D. HISTORY OF RADIATOR	4
E. RADIATOR COOLANT	5
F. RADIATOR INSTALLATION	7
G. RADIATOR FREQUENT FAILURES	8
1. Contamination	9
2. Corrosion	10
3. Corrosion in Oil Cooler	11
4. Electrolysis	12
5. Thermal Shock	13
6. Radiator Cap	14
H. WELL MAINTAINED	15

A

How Radiator Work?



Radiator are heat exchanges used to transfer thermal energy for the purpose of cooling the engine.

The two main indirect by products of any reciprocating engine is heat and vibration. They are both damaging and need to be managed. Without managing them, the engine will fail prematurely.

Radiator takes away the wasted heat generated from the engine. It does this by the use of coolant running along the engine capillaries on the engine wall.

Coolant is pumped via the water pump to the radiator and air is blown across the fin of the radiator to help radiate away the heat.

The air is blown via a fan and also induced along the flow of the vehicle direction, when in motion.

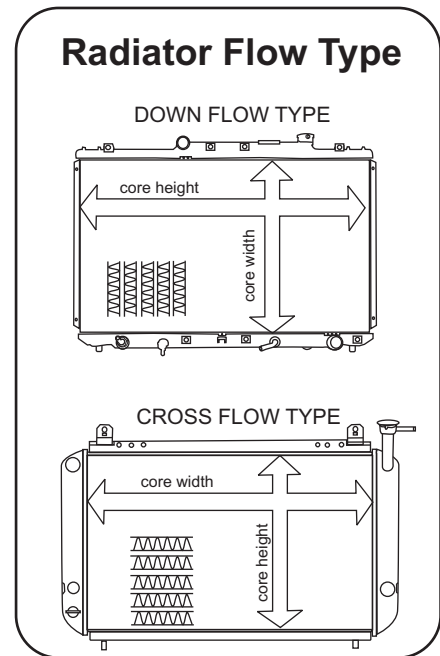
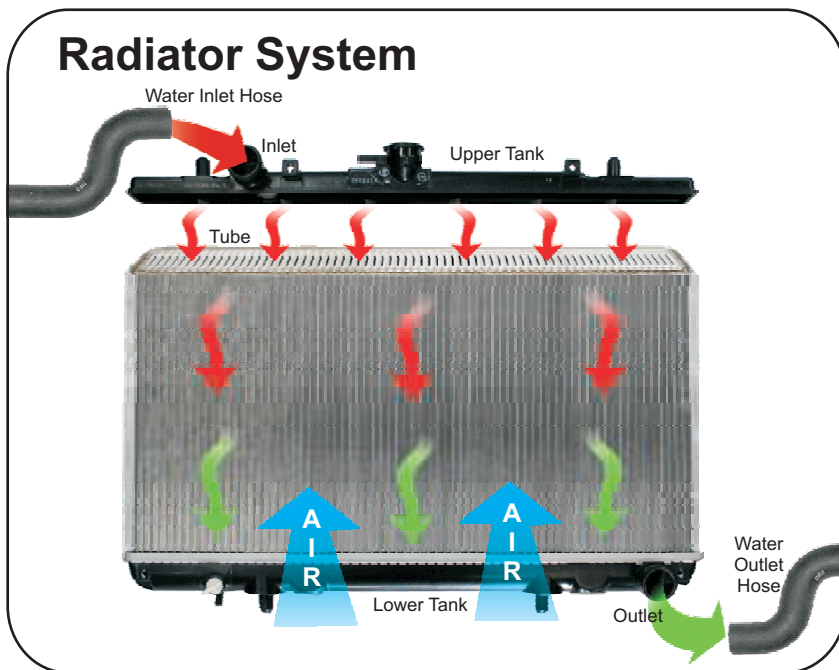

WHAT IS RADIATOR?

B

RADIATOR PARTS

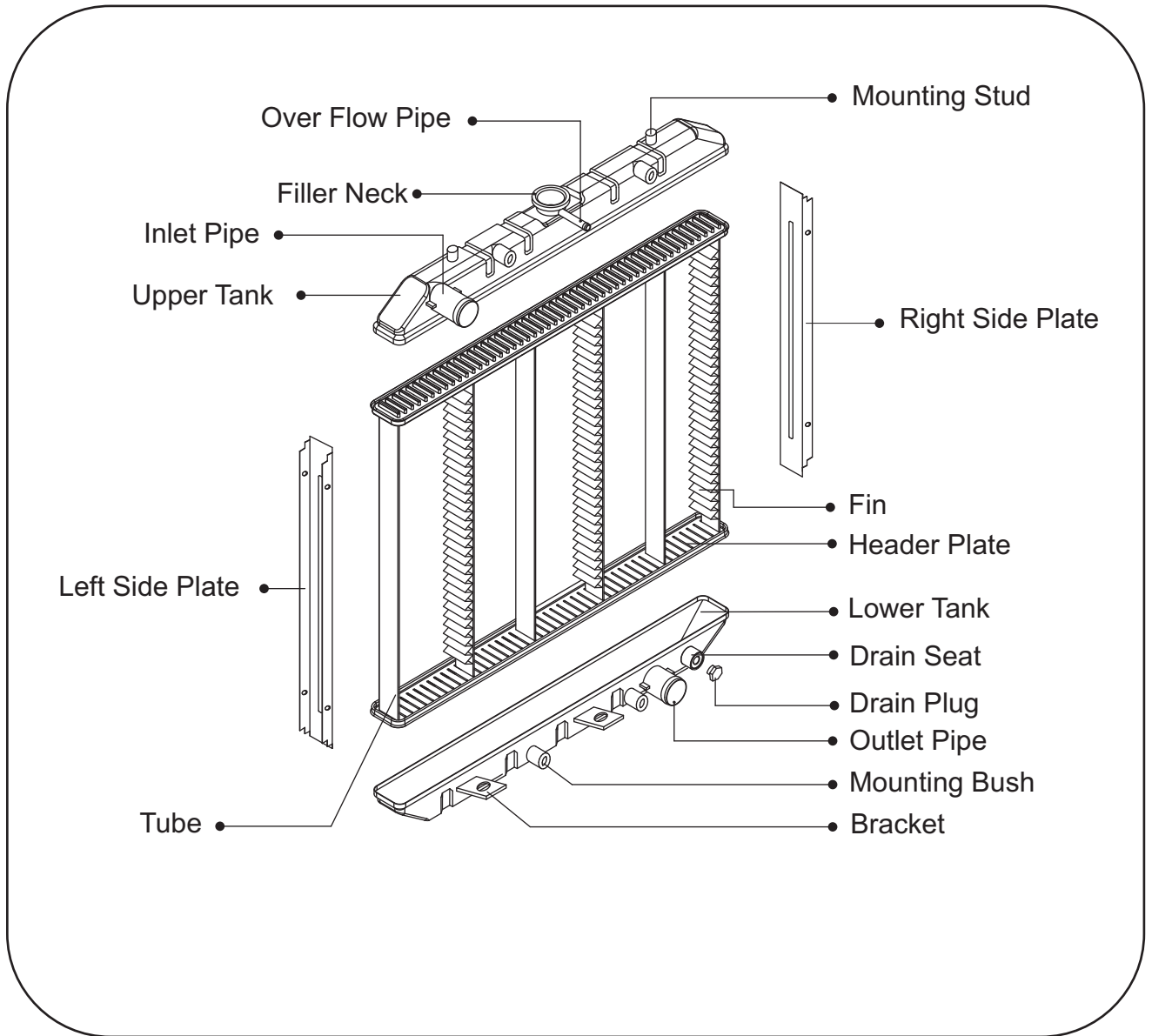



ENGINE COOLING SYSTEM

how
the system works?

Cooling System

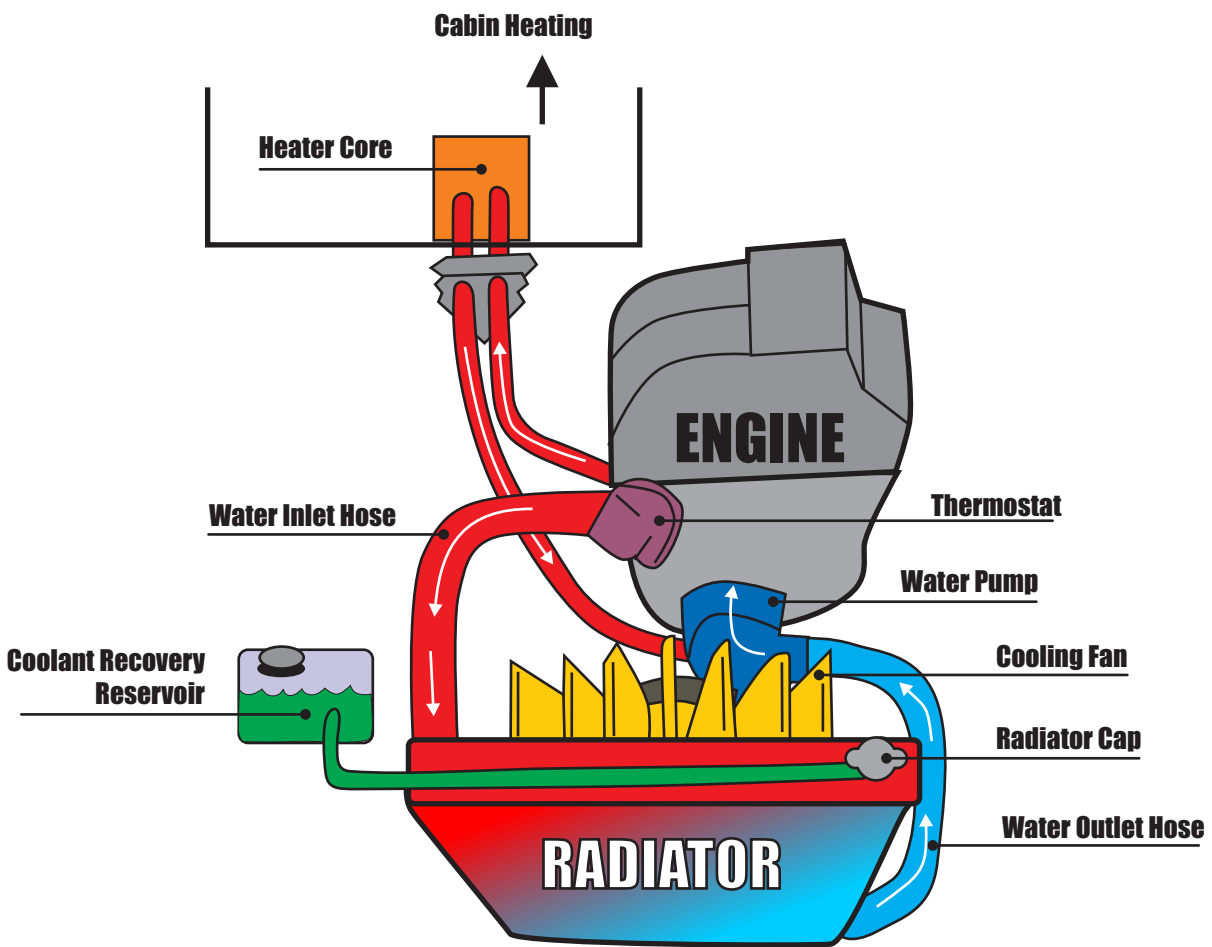

HISTORY OF RADIATOR



The history of radiator



1

First Generation

(1900s – 1970s)

Copper/Brass 100%



2

Second Generation

(1970s – early 1990s)

Aluminum gains,
Copper brass with plastic tank



3

Third Generation

(1990s – 2000s)

Aluminum with plastic tank



Today, many copper/brass radiators have been replaced with aluminum radiators. You can find the equivalent ADR copper/brass in aluminum by your radiator specialist. The aluminum radiators are designed to meet or exceed the vehicle's requirement.

RADIATOR COOLANT

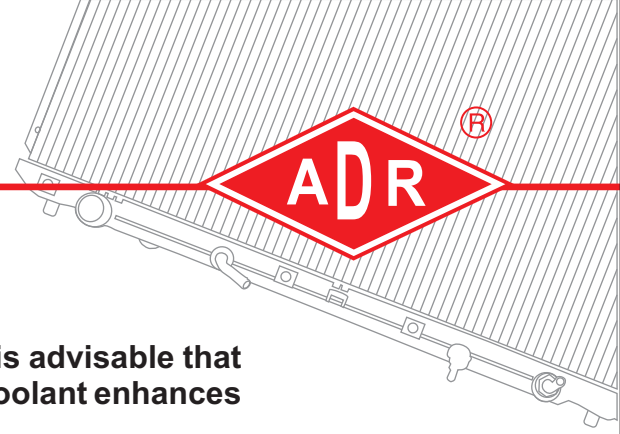

Coolants for radiators need careful consideration and it is advisable that different coolants should not be mixed at any one time. Coolant enhances the dissipation of heat in the radiator.

Characteristics and Requirements of an Engine Coolant:

- 1) High specific heat and good thermal conductivity.
- 2) Fluidity within the temperature range in use.
- 3) Low freezing point.
- 4) High boiling point.
- 5) Non-corrosive to metals, minimal degradation of non-metals.
- 6) Chemical stability over the temperature range and conditions of use.
- 7) Non-foaming.
- 8) Low Flammability; high flash point.
- 9) Reasonable compatibility with other coolants or oil.
- 10) Low toxicity; no unpleasant odor.
- 11) Reasonable cost; available in large quantities.



A typical coolant concentrate composition is :

- Ethylene glycol, 80%
- Other glycol's
- Multi-inhibitor system
- Buffer or neutralizer
- Foam suppressor
- Dye
- Water



In a number of new vehicles, the manufacturer has opted for an organic formulation.

IMPORTANT!

1. Completely drain water & flush from system before installing new radiator.
2. Choose a manufacturer's recommended coolant.
3. Do not mix coolant.

RADIATOR INSTALLATION

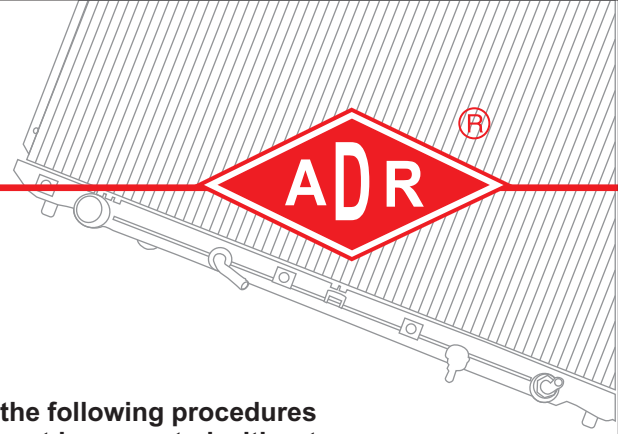

WARNING

Failure to install this Radiator assembly without strictly adhering to the following procedures will void the Radiator manufacture's warranty. A warranty claim will not be accepted without producing a fully completed and signed installation certificate, accompanied by a copy of the vehicle owner's purchase invoice.

INSTALLATION INSTRUCTIONS OVERLEAF

PART A - INSTALLING NEW RADIATOR (REPLACING OLD, FAULTY, OR DAMAGED RADIATOR EXISTING IN VEHICLE)

1. Prior to removing the existing radiator, the cooling system must be inspected to evidence of stray/ electric current (this is only possible when the cooling system is still operation). Stray/ electric current causes a highly destructive form of corrosion (electrolysis). This is caused by the passage of even the smallest (.05 volt) current through the coolant in the system. The resulting fast acting corrosion attacks not only the radiator and heater cores, but can also cause severe and expensive damage to alloy cylinder heads, water pumps, thermostats, and other components parts, including the auto-transmission. This condition occurs within the cooling system, mainly due to current seeking an easy path through the coolant in search of ground. Typically, this is a result of accident damage to vehicle, poor installation of electrical components, and faults occurring in electrical components.

Use an analog voltmeter (with a sensitivity of .05 volts), or a stray current detector to check for presence of electrical current by placing the positive lead directly into the coolant (filler neck on the radiator), or in the overflow bottle (for closed system), making sure the terminal is not contact with any surrounding metal surface. Attach the negative lead to the battery earth (negative terminal), and switch on all of the vehicles' electrical systems, one a time. First with the engine running, and then, repeat the process with the engine off. A reading of more than .05 volts or a positive' (red light) indicates a damaging current is likely to be present in the cooling system. This procedure will enable you to establish, by process of elimination, the source of the current. It is imperative that the source of any current traveling through the coolant is located, and repaired or replaced prior to installing a new radiator assembly,

Note : Additional electrical accessories can be the source of stray current. If additional accessories are fitted or repairs have been undertaken, repeat stray current check.

WARNING – DO NOT PROCEED IF UNABLE TO DETECT SOURCE OF CURRENT. CONSULT A QUALIFIED AUTO ELECTRICIAN FOR ASSISTANCE.

2. Completely drain the coolant from the system.
3. Fill the system with water and treat with a quality alkaline cooling system flushing agent (normally 500 ml per 12 liters). Observe the instructions on the container (ensure the vehicle's heater is turned on, and the radiator overflow bottle is clean).
4. Check components such as the radiator cap, hoses, clamps, thermostat, water pump and fan/s for wear and current condition.
5. Drain water from the system and flush out with clean water.
6. Carefully remove the old radiator assembly and check mountings.
7. Correctly install the new radiator assembly – replace faulty or worn components. Check vehicle service manual for any additional procedures applicable to radiator installation.
8. Fill system with clean water and perform stray/ electric current test procedure as outlined in item 1. Proceed if result if negative.
9. Completely drain water from the system.
10. Install the recommended coolant (type and dosage) for this vehicle, as specified by the vehicle manufacturers' service manual. When using a concentrated inhibitor, use distilled or demineralized water.

Do not mix coolant brands or type together. Correct coolant selection and installation is essential to ensure maximum corrosion protection for all component parts within engine cooling system.

Coolants/inhibitors are added to the cooling system for three reasons :

- a) To increase the boiling and freezing point of the water.
- b) To lubricate those moving parts of the engine which are in contact with water.

F. RADIATOR INSTALLATION



c) To provide a film barrier between the potentially corrosive water and the various types of metals found within the engine and cooling system.

This protective barrier is being continually replaced by the inhibitor the corrosive elements of the water dissolve the barrier. This is the continuing process and the coolant/ inhibitors become depleted after a time to a point where they no longer provide a protective coating.

Alkaline corrosion will begin on the inside of the radiator tubes. Coolant/ inhibitors from different manufacturers have different chemical compounds which may adversely react if mixed. It is important not to create a chemical cocktail by mixing different brands of coolant/ inhibitor.

11. Replace radiator cap and tighten firmly.
12. Run vehicle engine up to normal operating temperature and inspect all components for leaks .

WARNING: DO NOT REMOVE RADIATOR CAP.

13. Fully complete and sign the attached radiator installation certificate. Failure to do so may void the radiator manufacturer's warranty. (keep the certificate in the glove box).
14. Vehicle must be returned to an authorized radiator repair center every 12 months (25,000 kms) for routine maintenance.

PART B – INSTALLING A NEW RADIATOR

AS THE ORIGINAL RADIATOR IS MISSING OR DAMAGED (COOLANT ABSENT), NO INITIAL STRAY/ ELECTRIC CURRENT TEST CAN BE PERFORMED.

1. Correctly install the new radiator assembly – replace faulty or worn components (i.e. radiator cap, hoses, clamps, thermostat, water pump, fan/s and fan belts). Check vehicle service manual for any additional procedures applicable to radiator installation.
2. Fill the system with water and treat with a quality alkaline cooling system flushing agent (normally 500 ml per 12 liter). Observe the instructions on the container. (Ensure the vehicle's heater is turned on and radiator overflow bottle is clean).
3. Drain and flush the system and refill with clean water.
4. Perform stray/electric current test as detailed in part A, item 1. Proceed with installation if result is negative. If a positive result is noted, do not proceed – consult a qualified auto electrician.

5. Completely drain water from the system.
6. Select and properly install the recommended coolant (type and dosage) for this vehicle, as specified by the vehicle manufacturers' service manual.

Do not mix coolant brands or type together. Correct coolant selection and installation is essential to ensure maximum corrosion protection for all component parts within the engine cooling system. (Refer to part A, item10).

7. Replace radiator cap and tighten firmly.
8. Run vehicle engine up to normal operating temperature and inspect all component for leaks.

WARNING: DO NOT REMOVE RADIATOR CAP

9. Fully complete and sign the attached radiator installation certificate. Failure to do so may void the radiator manufacturer's warranty. (Keep the certificate in the glove box).
10. Vehicle must be returned to an authorized radiator repair center every 12 months (25.000 kms) for routine maintenance.

CONGRATULATIONS!

You have correctly installed a quality radiator assembly, and manufacturer's warranty is now offered conditionally. Correct installation procedures, quality coolant protection, and a routine maintenance schedule will greatly any unnecessary expense and inconvenience.

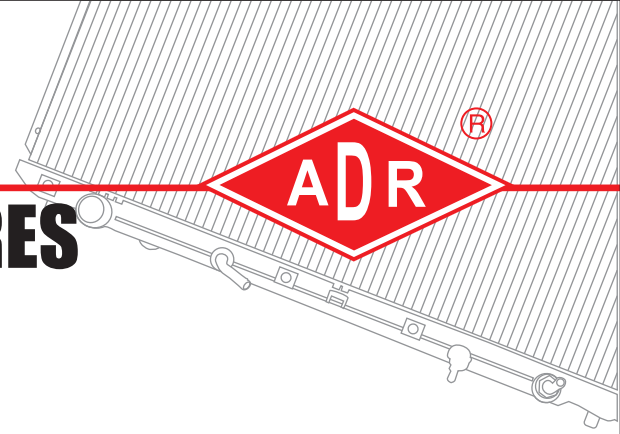

what

are the radiator frequent failures?

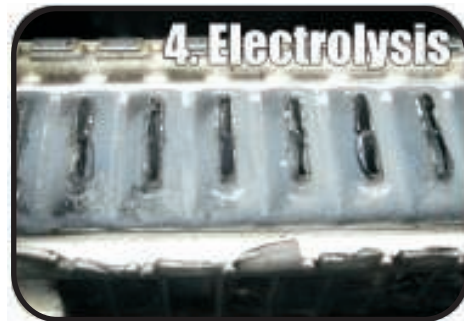

G. RADIATOR FREQUENT FAILURES



1. Contamination

Foreign matter inside the radiator

what
are the cause
and result?

CAUSE

- Improper flushing of the engine cooling system prior to installation of new radiator.
- Insufficient levels of fluid in the system for prolonged periods
- Contamination of the engine cooling system.

RESULT

- Blockages of the radiator's tube, Header Plate and Tank.
- Reduction in cooling performance and efficiency.
- Engine overheating.
- Deterioration and failure of critical radiator components causing loss of coolant.

how
to prevent
the contamination?

PREVENTION

- Regular service of cooling system.
- Use Manufacturer's recommended coolant.
- Proper flushing of cooling system during coolant change



Leak caused by contaminated coolant



Large deposit of foreign matter inside the radiator tank



The header plate and inside the tube are covered with brown residue

G. RADIATOR FREQUENT FAILURES

2. Corrosion

Mechanical and Chemical deterioration of the radiator's tubes and header plates leading to holes and cracks in the core.



what
are the cause
and result?

CAUSE

- Improper flushing of the engine cooling system prior to installation of new radiator.
- Mixing of coolants in to the system.
- Additive usage.

RESULT

- Severely reduced corrosion protection.
- Tubes become weak and brittle and eventually develop holes and cracks.
- Reduction in cooling performance and efficiency, leading to conditions such as overheating.
- Loss of coolant.

how
to prevent
the corrosion?

PREVENTION

- Regular service of cooling system.
- Use manufacturer's recommended coolant.
- Proper flushing of cooling system during coolant change.
- Use the same coolant, do not mix coolant.

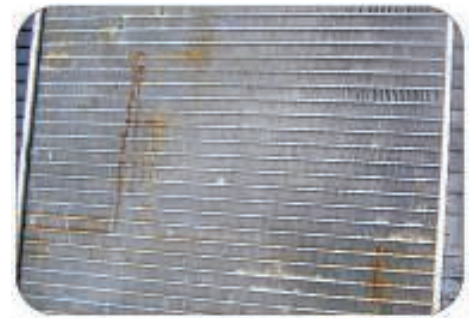

Evidence of corrosion on the radiator tubes.

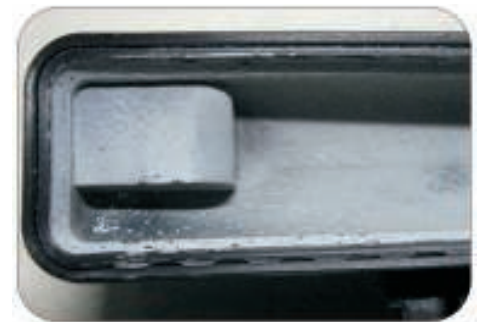

Lower tank covered in white residue



The tubes on the header plate have become brittle and broken away

G. RADIATOR FREQUENT FAILURES

3. Corrosion in Oil Cooler

Oil cooler failure is often caused by pitting corrosion, which is mainly due to the following factors..

what
are the cause
and result?

CAUSE

- Improper flushing of the engine cooling system prior to installation of new radiator.
- Mixing of coolants into the system.
- Incorrect concentration of coolant either at the time of change over or caused by dilution over a period of time.
- Contamination of the engine cooling system.

RESULT

- The mixing of coolant / auto transmission fluid.
- Coolant enters automatic transmission.
- Damaging other cooling system components i.e. hoses.
- Pitting corrosion.

how
to prevent
the corrosion in oil cooler?

PREVENTION

- Regular service of cooling system.
- Use manufacturer's recommended coolant
- Proper flushing of cooling system during coolant change.
- Use the same coolant, do not mix coolant.

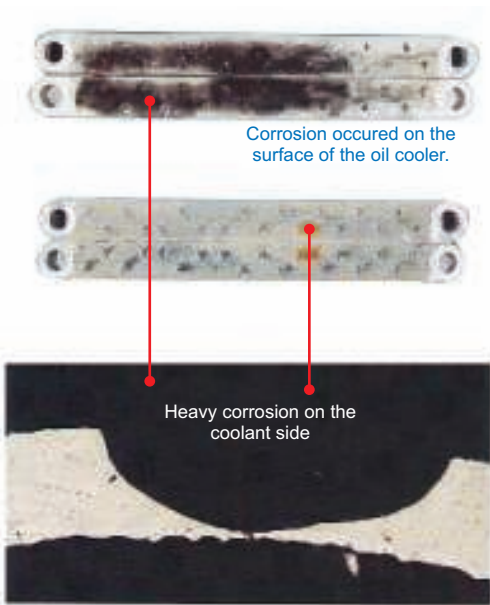

Oil cooler cut out section.
Cross section magnified by 100x

Corrosion in Oil Cooler

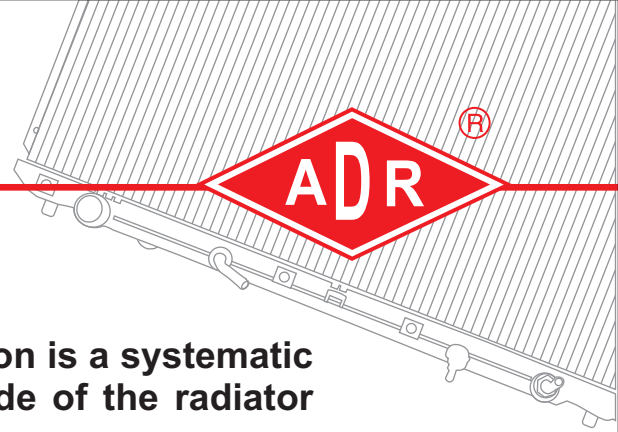

4. Electrolysis

Also commonly called **stray current corrosion** is a systematic removal of the protective layer on the inside of the radiator tubes due to improper grounding.

what
are the cause
and result?

CAUSE

- Poor installation of accessories.
- Existing stray current problem was not diagnosed an/or repaired prior to fitting a new radiator.
- Poorly grounded electrical components due to vehicle collision damage.

RESULT

- Systematic removal of the corrosion protection layer on the inside of the Radiator's tubes.
- Corrosion of the tubes typically resulting in multiple holes.
- Build-up of aluminum oxide blocking passages.
- White aluminum oxide powder on the inlet and outlet pipes.

how
to prevent
the electrolysis?

PREVENTION

- Test for stray current in the cooling system
- Repair poor electrical grounding (check aftermarket accessories fitment)



Dark pigmentation along the fins



Blackening of the header plates. The tubes and brazed joints have corroded away.



Top header plate discoloured



Evidence of aluminium oxide residue settle inside the tank.

G. RADIATOR FREQUENT FAILURES

5. Thermal Shock

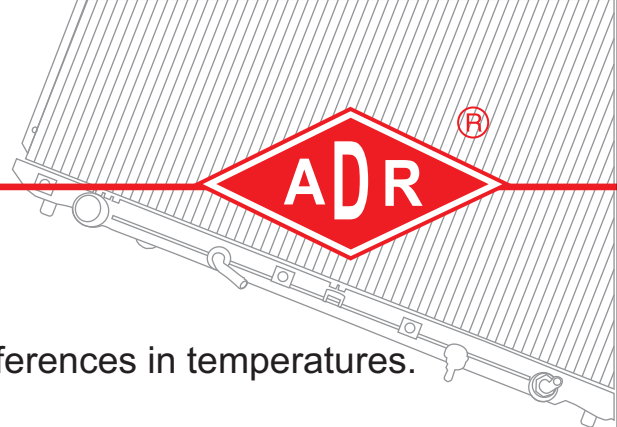

Thermal Shock / Stress is caused by drastic differences in temperatures.
Note: This only occurs in some models.

what
are the cause
and result?

CAUSE

- Hot/Cold coolant and pressure surges slam against the inlet side of the radiator.

RESULT

- Tube fatigue failure.
- Leaking tube to core plate near inlet pipe.
- Leak will only starts as slow seepage.

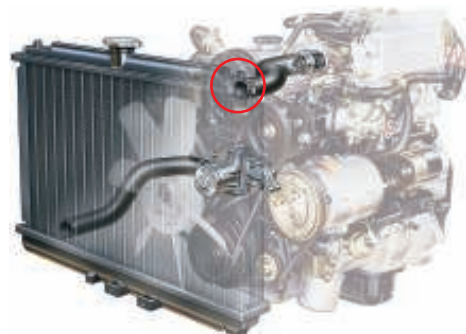

Big temperature difference when hot coolant enters radiator causing tubes to flex.

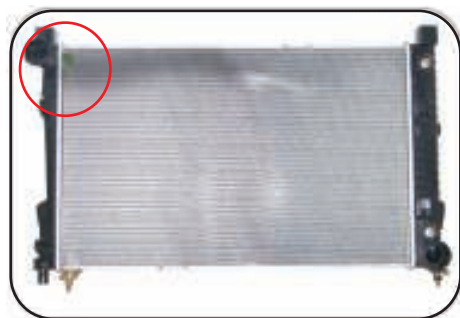

Thermal shock affects tubes on the inlet side



Coolant leakage, as a result of thermal shock.

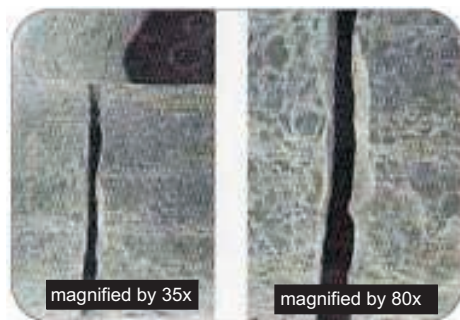

Cut out tube section with crack

REPAIR METHOD

Note: These repair methods are only effective for some models.
Install thermostat with bleed hole, this will reduce thermal fluctuations by softening thermostat influence.
Consult your repair shop for a replacement radiator.

how
to prevent
the thermal shock?

PREVENTION

- Always use a product from a renowned manufacturer.
- Maintenance of coolant is also very important any corrosion to tube wall accelerate tube fatigue.

G. RADIATOR FREQUENT FAILURES

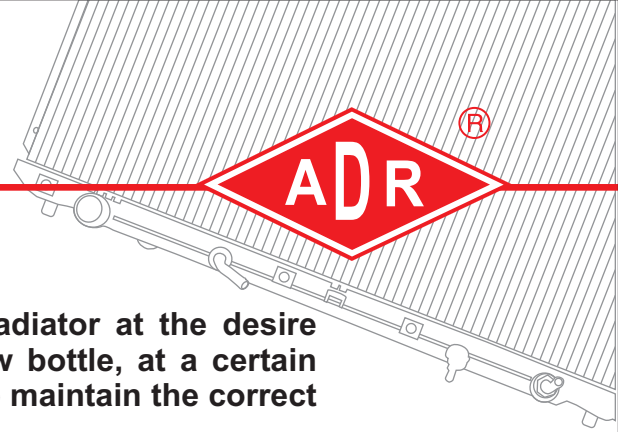

6. Radiator Cap

The radiator cap keeps the coolant level in the radiator at the desired amount. The cap releases coolant to the overflow bottle, at a certain pressure, then draws it back as the engine cools, to maintain the correct coolant level.

what are the radiator frequent failures?

CAUSE

- Cracked gasket
- Missing rubber seal
- Melted by heat
- Swollen Gasket
- Weak spring tension

RESULT

- Coolant leaking from radiator. Pressure not maintained.
- Over pressure caused by fluid not being able to be forced over the flow bottle.

how to prevent the radiator cap problem?

PREVENTION

- When checking the coolant, also check the radiator cap for worn or cracked rubber gaskets. If the cap does not seal properly fluid will be lost and the engine will overheat.
- A pressure test should be performed on your radiator cap to ensure it is working properly.

A weak radiator cap (or the wrong one for the application) can allow excessive amounts of coolant to escape into the overflow reservoir when the engine gets hot, then prevent it from being siphoned back into the radiator as the engine cools leading to a low coolant level. So always pressure test the cap to make sure it holds pressure and meets the specifications for the application.



Cracked / worn gasket



Swollen Gasket



Radiator Cap

Pressure test on radiator cap

WELL MAINTAINED



TUBES

The radiator tubes were clear and appeared to be good.



PLATES

The header plate was clear. No sign of corrosion and contaminant.

OIL COOLER

No visual sign of corrosion on the oil cooler.

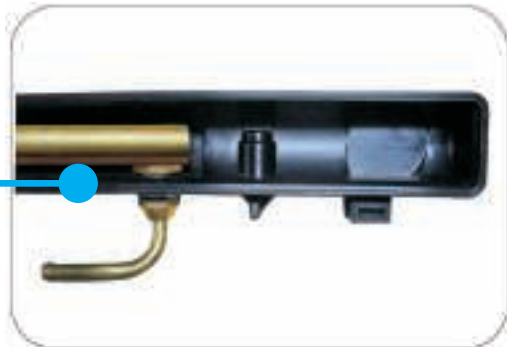

TANK

No sign of excessive residue or foreign materials in the tank

Sales & Marketing Division

Tel : (62-21) 559 50304

Fax : (62-21) 555 1905

E-mail : export@adr-group.com

Website : www.adr-group.com



IATF 0087004
SGS ID03/0146.2
ISO/TS 16949

Manufactured by ADR Group of Companies

This material is an internal use document and strictly prohibited to make copies, change or distribute out of ADR Group of Companies usage